

INSTALLATION INSTRUCTIONS FOR MODELS SS300, SS305, SS315

PACKAGE INCLUDES

- 1 Hinge



SS300

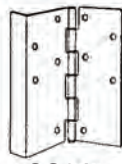

SS315

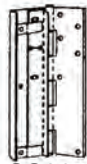

SS305

- #10 x 1/2" self drilling screw for metal doors & frames



number of screws for
7' hinge 8' hinge 10' hinge

42 46 54

- #10 x 1" wood screw for wood doors



21 23 27

TOOLS NEEDED

- 12' tape measure



- Center punch



- #2 pt. Phillips head screw driver bit



- Metal cutting saw (if hinge must be cut to fit door or frame)



- 3/8" power drill or screw gun



- Angled block or similar device for holding door in position



- marking pen



- Hammer



- Square for marking hinge cut off line



- Flat file



INSTRUCTIONS FOR INSTALLING MODELS SS300, SS305, SS315

NOTE: before proceeding, check to be sure that hinge is proper size. Height of hinge should be 7/8 inch LESS than opening height. See other side of page for cutting instructions.

STEP 1 - Mark Frame Hole Locations

- Determine TOP of hinge using door and frame as guide.
- Open hinge and place frame leaf flat against surface of frame leaving 1/8 inch gap between top of hinge and frame header, and 1/16 inch gap between edge of hinge and stop.
- Mark hole locations on frame using center punch. A center punch mark is required to start self drilling screws accurately.

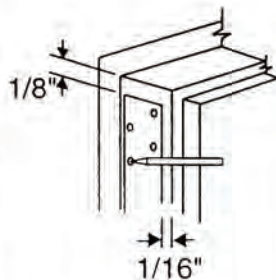

DO NOT INSTALL HINGE TO FRAME AT THIS TIME!

STEP 2 - Mount Hinge to Door

- Place door leaf of hinge against hinge edge of door so that top of hinge is flush with top of door and edge of hinge leaf is flush with inside face of door - for models SS305 and SS315, door edge guards must lay flat against face of door.
- With hinge held firmly in place, use #10 x 1/2 inch self drilling screws to fasten leaf to metal door, or #10 x 1 inch wood screws to fasten leaf to wood door. NOTE: Fasten top most screw first, and bottom most screw second making sure that hinge is aligned correctly.

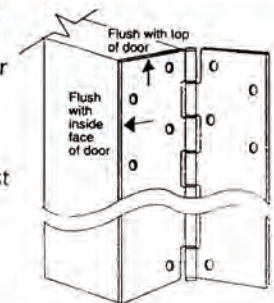

ALL HOLE LOCATIONS ON HINGE LEAF MUST BE FASTENED TO DOOR FOR PROPER OPERATION. FAILURE TO INSTALL ALL FASTENERS WILL VOID WARRANTY AND UL FIRE LABEL LISTINGS.

STEP 3 - Mount Door to Frame

- Move door into opening and align mounting holes in frame leaf of hinge with marks on frame made in step 1 above. NOTE: an angle block, jack or shims will be helpful in positioning the door properly.
- With hinge and door held firmly and accurately in place, use #10 x 1/2 inch self drilling screws to fasten frame leaf of hinge to frame in marked locations.

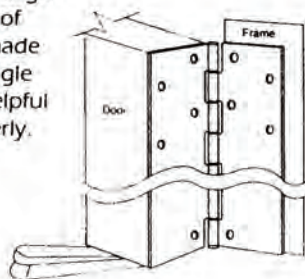

ALL HOLE LOCATIONS ON HINGE LEAF MUST BE FASTENED TO FRAME FOR PROPER OPERATION. FAILURE TO INSTALL ALL FASTENERS WILL VOID WARRANTY AND UL FIRE LABEL LISTINGS.

STEP 4 - Check for Proper Operation

- Close door and check for proper operation and clearances. There should be 1/8 inch clearance between the top of the door and bottom of the frame header, and 1/8 inch clearance between the frame and edge of the door when door is closed. Adjustments can be made by shimming frame or door leaf of hinge.

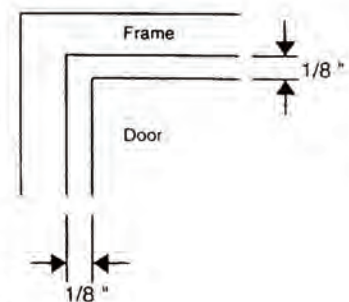

INSTRUCTIONS FOR CUTTING 300 SERIES CONTINUOUS HINGES

STEP 1 - Determine Hinge Height

- Measure height of opening from finished floor to underside of door frame header.
- Hinge height is height of opening MINUS 7/8 inch.

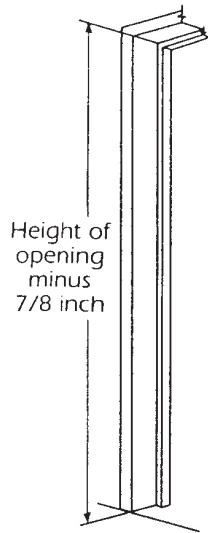

STEP 2 - Mark Hinge for Cutting

- Determine which end of hinge will be the TOP using door and frame as a guide.
- Open hinge to expose back of hinge (holes are NOT countersunk).
- Measure hinge height calculated in step 1 from TOP of hinge.
- Using square, mark a line on back of both hinge leaves and the barrel.

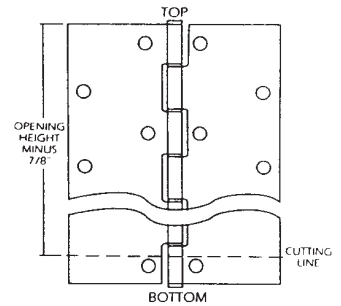

DOUBLE CHECK MEASUREMENT BEFORE CUTTING!

NOTE: cut end of hinge must be used as BOTTOM OF HINGE ONLY!

STEP 3 - Cut Hinge

- Fold hinge so that cut line is visible.
- Starting on barrel, cut through entire hinge along line.
- Debur all cut edges with file.

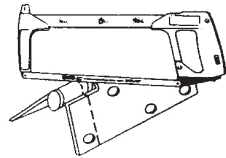

- Use center punch or heavy gauge nail on pin in short cut off portion of hinge to remove hinge tip. **SAVE HINGE TIP** for use in step 5.

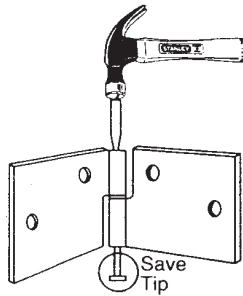

STEP 4 - Shorten Hinge Pin 3/4"

- Using center punch or heavy gauge nail, tap on cut surface of hinge pin to remove top hinge tip (Save tip for Step 5).
- Expose 1" of hinge pin. Measure and mark 3/4 inch from end of pin. **DOUBLE CHECK MEASUREMENT BEFORE CUTTING.**
- Cut pin at mark.

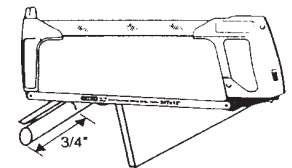
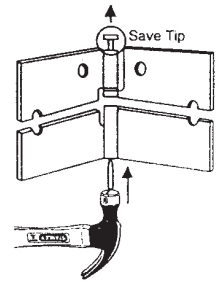

STEP 5 - Insert Top & Bottom Tip

- Tap hinge pin back into barrel.
- Tap hinge pin tips retained from step 3 & 4 above firmly into top & bottom of barrel until shoulder sits squarely on barrel. **NOTE** both tips **MUST BE INSTALLED** to hold hinge pin in position.

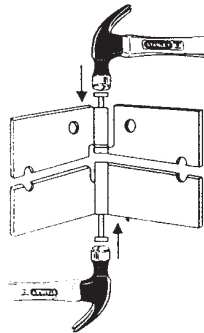

IMPORTANT NOTE:

IF MORE THAN 6 INCHES IS CUT FROM BOTTOM OF HINGE, ADDITIONAL MOUNTING HOLES WILL BE REQUIRED ON BOTTOM OF HINGE. USE CUT OFF PIECE OF HINGE TO MARK AND PREPARE HOLE LOCATIONS ON BOTTOM OF HINGE.